

COLLECTION DE POÊLES À GRANULÉS PELLET STOVES COLLECTION





Le numéro 1 en Europe sur le marché des poêles à granulés
The number 1 in Europe in the pellet stove market

Qualité 100% italienne
100% Italian quality

MCZ GROUP

RED est une marque de MCZ GROUP, entreprise leader au niveau mondial et le numéro un en Europe pour la production de poêles à granulés. RED est la marque qui s'adresse exclusivement aux grossistes avec un projet et une gamme de produits dédiés.

RED is a brand of MCZ GROUP, the world leader and Europe's number one in the production of pellet stoves. RED is the brand conceived only for wholesalers with a project and a dedicated product range.

Tous les produits du groupe MCZ sont conçus, développés, industrialisés et fabriqués en Italie, dans l'usine de Vigonovo di Fontanafredda (Pordenone).

All MCZ Group products are designed, developed, industrialised and manufactured in Italy, at the plant of Vigonovo di Fontanafredda (Pordenone).

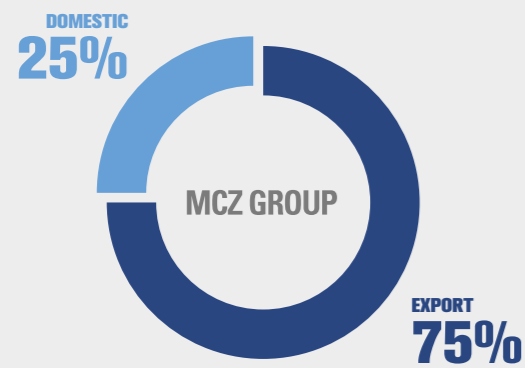

Chiffre d'affaires mixte / Turnover statistics

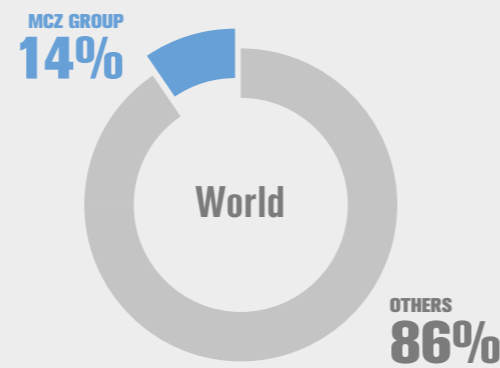

Ventes de poêles à granulés dans le monde / Pellet stove sales worldwide

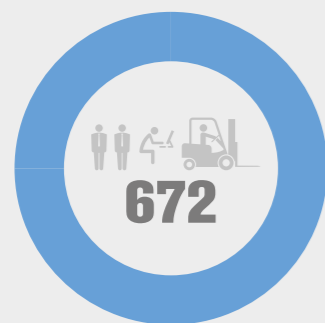

Ressources humaines / Human resources



Plus de 40 pays dans le monde / Over 40 countries worldwide



Siège et site de production / Headquarters and production site

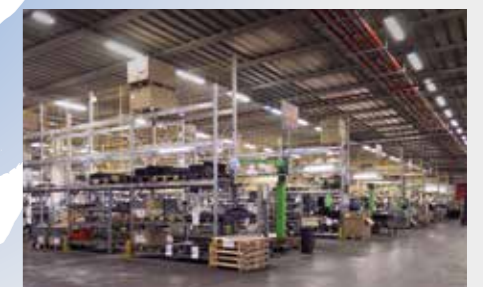

Lignes de montage / Assembly lines



R&D laboratoires / R&D laboratories



Entrepôts et logistique / Warehouses and logistics

Les produits RED ont déjà été projetés en tenant compte des restrictions sévères de la réglementation Ecodesign 2022 en matière d'impact environnemental.

The RED products were designed in accordance with the strictest provisions of the Ecodesign 2022 regulations on lowering emissions.

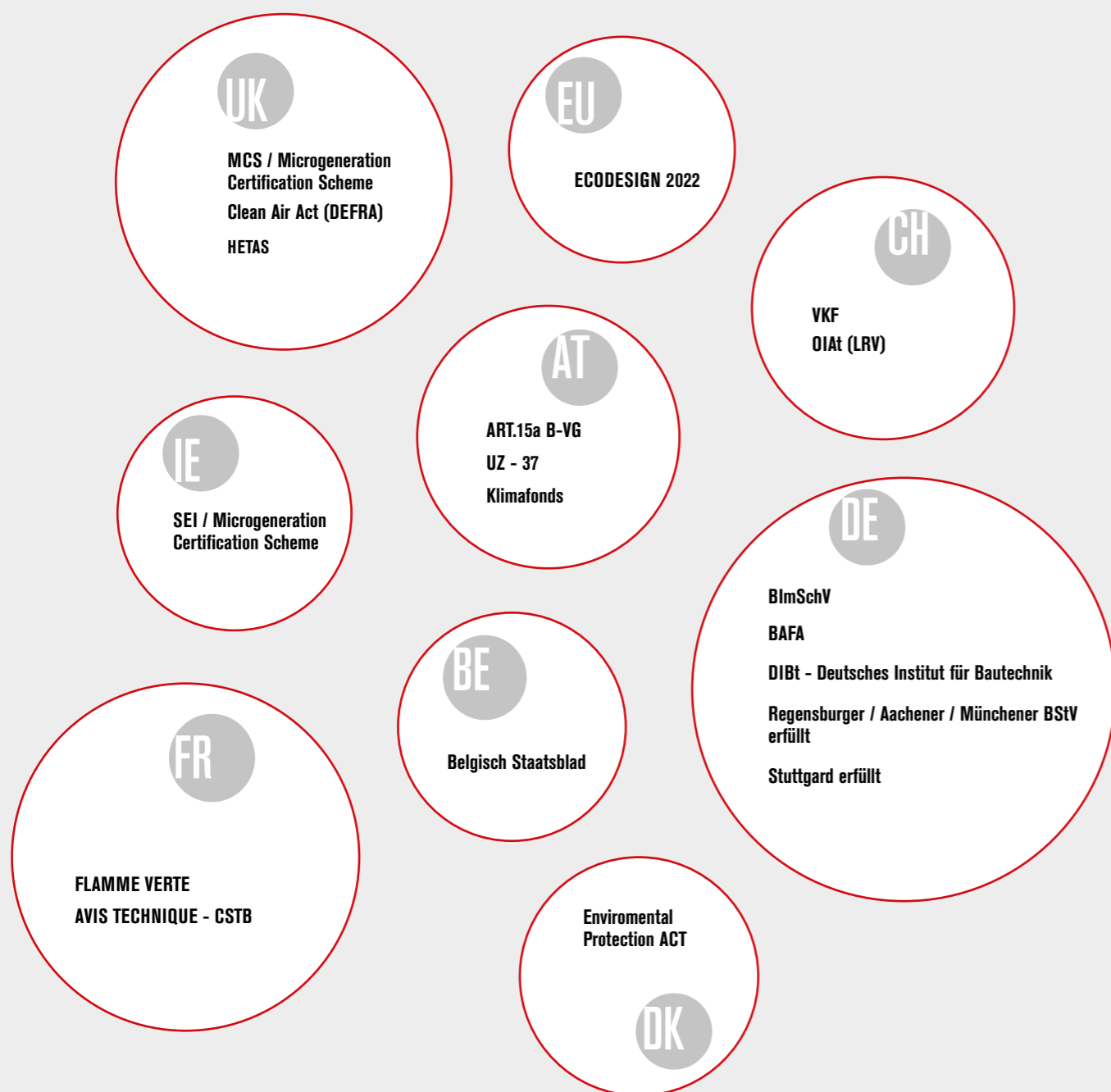

FLAMME NATURELLE

Les produits RED sont caractérisés par une flamme au rendu plus naturel et esthétique avec une grande vision de la flamme.

NATURAL FLAME

RED products are characterised by a more natural and aesthetically pleasing flame with a large flame vision.



CONDUIT COAXIAL DES FUMÉES

Conduit coaxial des fumées (évacuation des fumées/aspiration de l'air comburant).

COAXIAL FLUE GAS DUCT

Coaxial flue gas duct (flue gas discharge/ combustion air intake).



ALLUMAGE RAPIDE

Allumage et atteinte de la combustion avec le niveau de puissance souhaité en quelques minutes.

QUICK IGNITION

Lighting and achieving combustion with the desired power level in a few minutes.



UTILISATION À PARTIR DE SMARTPHONE ET TABLETTE

App dédiée, il est également possible de gérer et programmer le poêle depuis un smartphone ou depuis une tablette, aussi bien dans la maison qu'à distance.

USE FROM SMARTPHONES AND TABLETS

Thanks to a dedicated app it is also possible to manage and program the stove from a smartphone or tablet, both locally and remotely.



FONCTIONNEMENT SILENCIEUX

La ventilation forcée du poêle peut se limiter à son minimum, permettant ainsi un maintien de la température tout en garantissant un silence absolu.

SILENT OPERATION

The forced ventilation of the stove can be limited to the maximum, allowing the temperature to be maintained while ensuring absolute silence.



HERMÉTIQUES

Grâce à une structure parfaitement étanche, le poêle ne consomme pas l'oxygène de la pièce. En récupérant tout l'apport d'air provenant de l'extérieur, il peut ainsi être installé dans tout type d'habitat y compris les maisons passives.

HERMETICS

Thanks to a perfectly sealed structure, the stove does not consume any oxygen in the room. By recovering of all the air coming from the outside, it can be installed in all types of premises, including passive houses.



RED, une gamme ciblée de poêles pour tous les besoins
 RED, a targeted range of stoves to meet all needs



Kunal 6
6 kW



Kunal 6 XUP!
6 kW



Kunal 8
8 kW



Kunal 8 XUP!
8 kW



Ren 6
6 kW



Ren 6 XUP!
6 kW



Ren 8 XUP!
8 kW



Dalia
6 kW



Melissa XUP!
7 kW

Gestion du poêle également à partir du smartphone
 Stove management even from smartphone

<input checked="" type="checkbox"/>	<input checked="" type="checkbox"/>	<input checked="" type="checkbox"/>	<input checked="" type="checkbox"/>	<input checked="" type="checkbox"/>	<input checked="" type="checkbox"/>	<input checked="" type="checkbox"/>	<input checked="" type="checkbox"/>	<input checked="" type="checkbox"/>	<input checked="" type="checkbox"/>
-------------------------------------	-------------------------------------	-------------------------------------	-------------------------------------	-------------------------------------	-------------------------------------	-------------------------------------	-------------------------------------	-------------------------------------	-------------------------------------

Kit Wi-Fi Easy Connect de série
 Easy Connect Wi-Fi kit as standard

<input checked="" type="checkbox"/>	<input checked="" type="checkbox"/>	<input checked="" type="checkbox"/>	<input checked="" type="checkbox"/>	<input checked="" type="checkbox"/>	<input checked="" type="checkbox"/>	<input checked="" type="checkbox"/>	<input checked="" type="checkbox"/>	<input checked="" type="checkbox"/>	<input checked="" type="checkbox"/>
-------------------------------------	-------------------------------------	-------------------------------------	-------------------------------------	-------------------------------------	-------------------------------------	-------------------------------------	-------------------------------------	-------------------------------------	-------------------------------------

Sortie des fumées supérieure coaxiale ø 8/13 cm
 Top coaxial smoke outlet ø 8/13 cm

<input type="checkbox"/>	<input checked="" type="checkbox"/>	<input type="checkbox"/>	<input checked="" type="checkbox"/>	<input type="checkbox"/>	<input checked="" type="checkbox"/>	<input checked="" type="checkbox"/>	<input type="checkbox"/>	<input type="checkbox"/>	<input checked="" type="checkbox"/>
--------------------------	-------------------------------------	--------------------------	-------------------------------------	--------------------------	-------------------------------------	-------------------------------------	--------------------------	--------------------------	-------------------------------------

Sortie des fumées supérieure ø 8 cm
 Top smoke outlet ø 8 cm

<input type="checkbox"/>	<input type="checkbox"/>	<input type="checkbox"/>	<input type="checkbox"/>	<input type="checkbox"/>	<input type="checkbox"/>	<input type="checkbox"/>	<input type="checkbox"/>	<input type="checkbox"/>	<input type="checkbox"/>
--------------------------	--------------------------	--------------------------	--------------------------	--------------------------	--------------------------	--------------------------	--------------------------	--------------------------	--------------------------

Sortie des fumées arrière ø 8 cm
 Rear smoke outlet ø 8 cm

<input checked="" type="checkbox"/>	<input type="checkbox"/>	<input checked="" type="checkbox"/>	<input type="checkbox"/>	<input checked="" type="checkbox"/>	<input type="checkbox"/>	<input type="checkbox"/>	<input type="checkbox"/>	<input checked="" type="checkbox"/>	<input type="checkbox"/>
-------------------------------------	--------------------------	-------------------------------------	--------------------------	-------------------------------------	--------------------------	--------------------------	--------------------------	-------------------------------------	--------------------------

Allumage rapide
 Quick ignition

<input checked="" type="checkbox"/>	<input checked="" type="checkbox"/>	<input checked="" type="checkbox"/>	<input checked="" type="checkbox"/>	<input checked="" type="checkbox"/>	<input checked="" type="checkbox"/>	<input checked="" type="checkbox"/>	<input checked="" type="checkbox"/>	<input checked="" type="checkbox"/>	<input checked="" type="checkbox"/>
-------------------------------------	-------------------------------------	-------------------------------------	-------------------------------------	-------------------------------------	-------------------------------------	-------------------------------------	-------------------------------------	-------------------------------------	-------------------------------------

Poêle étanche idéal pour maisons passives
 Sealed stove ideal for passive houses

<input checked="" type="checkbox"/>	<input checked="" type="checkbox"/>	<input checked="" type="checkbox"/>	<input checked="" type="checkbox"/>	<input checked="" type="checkbox"/>	<input checked="" type="checkbox"/>	<input checked="" type="checkbox"/>	<input checked="" type="checkbox"/>	<input checked="" type="checkbox"/>	<input checked="" type="checkbox"/>
-------------------------------------	-------------------------------------	-------------------------------------	-------------------------------------	-------------------------------------	-------------------------------------	-------------------------------------	-------------------------------------	-------------------------------------	-------------------------------------

Pour les petites pièces ou les couloirs
 For small rooms or halls

<input type="checkbox"/>	<input type="checkbox"/>	<input type="checkbox"/>	<input type="checkbox"/>	<input type="checkbox"/>	<input type="checkbox"/>	<input type="checkbox"/>	<input type="checkbox"/>	<input type="checkbox"/>	<input checked="" type="checkbox"/>
--------------------------	--------------------------	--------------------------	--------------------------	--------------------------	--------------------------	--------------------------	--------------------------	--------------------------	-------------------------------------

Poêle haute puissance pour les grandes maisons
 High-power stove for large houses

<input type="checkbox"/>	<input type="checkbox"/>	<input type="checkbox"/>	<input type="checkbox"/>	<input type="checkbox"/>	<input type="checkbox"/>	<input type="checkbox"/>	<input type="checkbox"/>	<input type="checkbox"/>	<input type="checkbox"/>
--------------------------	--------------------------	--------------------------	--------------------------	--------------------------	--------------------------	--------------------------	--------------------------	--------------------------	--------------------------

Emplacement du poêle d'angle
 Corner positioning of the stove

<input checked="" type="checkbox"/>	<input checked="" type="checkbox"/>	<input checked="" type="checkbox"/>	<input checked="" type="checkbox"/>	<input checked="" type="checkbox"/>	<input type="checkbox"/>	<input type="checkbox"/>	<input type="checkbox"/>	<input type="checkbox"/>	<input type="checkbox"/>
-------------------------------------	-------------------------------------	-------------------------------------	-------------------------------------	-------------------------------------	--------------------------	--------------------------	--------------------------	--------------------------	--------------------------

Chauffer plusieurs pièces (Multiair)
 Heat multiple rooms (Multiair)

<input type="checkbox"/>	<input type="checkbox"/>	<input type="checkbox"/>	<input type="checkbox"/>	<input type="checkbox"/>	<input type="checkbox"/>	<input type="checkbox"/>	<input type="checkbox"/>	<input type="checkbox"/>	<input type="checkbox"/>
--------------------------	--------------------------	--------------------------	--------------------------	--------------------------	--------------------------	--------------------------	--------------------------	--------------------------	--------------------------

Production d'eau chaude (Hydro)
 Hot water production (Hydro)

<input type="checkbox"/>	<input type="checkbox"/>	<input type="checkbox"/>	<input type="checkbox"/>	<input type="checkbox"/>	<input type="checkbox"/>	<input type="checkbox"/>	<input type="checkbox"/>	<input type="checkbox"/>	<input type="checkbox"/>
--------------------------	--------------------------	--------------------------	--------------------------	--------------------------	--------------------------	--------------------------	--------------------------	--------------------------	--------------------------

Fonctionnement silencieux à puissance réduite
 Silent operation at reduced power

<input checked="" type="checkbox"/>	<input checked="" type="checkbox"/>	<input checked="" type="checkbox"/>	<input checked="" type="checkbox"/>	<input checked="" type="checkbox"/>	<input checked="" type="checkbox"/>	<input checked="" type="checkbox"/>	<input checked="" type="checkbox"/>	<input checked="" type="checkbox"/>	<input checked="" type="checkbox"/>
-------------------------------------	-------------------------------------	-------------------------------------	-------------------------------------	-------------------------------------	-------------------------------------	-------------------------------------	-------------------------------------	-------------------------------------	-------------------------------------

Valorisation d'anciennes cheminées ou insert mural
 Valorisation of old fireplaces or wall insert

<input type="checkbox"/>	<input type="checkbox"/>	<input type="checkbox"/>	<input type="checkbox"/>	<input type="checkbox"/>	<input type="checkbox"/>	<input type="checkbox"/>	<input type="checkbox"/>	<input type="checkbox"/>	<input type="checkbox"/>
--------------------------	--------------------------	--------------------------	--------------------------	--------------------------	--------------------------	--------------------------	--------------------------	--------------------------	--------------------------



	Camelia 8 kW	Minta 8 kW	Hoya 8 kW	Althea 9 kW	Aster 10 kW	Malva 10 kW	Loto Hydro 16 kW Hydro 23 kW	Loto Multiair 14 kW	Fresia 9 kW
Gestion du poêle également à partir du smartphone Stove management even from smartphone	■	■	■	■	■	■	■	■	■
Kit Wi-Fi Easy Connect de série Easy Connect Wi-Fi kit as standard	■	■	■	■	■	■	■	■	■
Sortie des fumées supérieure coaxiale ø 8/13 cm Top coaxial smoke outlet ø 8/13 cm	□	□	■	□	■	□	□	□	□
Sortie des fumées supérieure ø 8 cm Top smoke outlet ø 8 cm	□	□	□	■	□	■	□	□	■
Sortie des fumées arrière ø 8 cm Rear smoke outlet ø 8 cm	■	■	□	■	□	■	■	■	□
Allumage rapide Quick ignition	■	■	■	■	■	■	■	■	■
Poêle étanche idéal pour maisons passives Sealed stove ideal for passive houses	■	■	■	■	■	■	■	■	□
Pour les petites pièces ou les couloirs For small rooms or halls	□	□	■	■	□	□	□	□	□
Poêle haute puissance pour les grandes maisons High-power stove for large houses	□	□	□	□	■	■	■	■	□
Emplacement du poêle d'angle Corner positioning of the stove	□	■	□	□	□	□	□	□	□
Chauffer plusieurs pièces (Multiair) Heat multiple rooms (Multiair)	□	□	■	■	■	■	□	■	□
Production d'eau chaude (Hydro) Hot water production (Hydro)	□	□	□	□	□	□	■	□	□
Fonctionnement silencieux à puissance réduite Silent operation at reduced power	■	■	■	■	■	■	■	■	□
Valorisation d'anciennes cheminées ou insert mural Valorisation of old fireplaces or wall insert	□	□	□	□	□	□	□	□	■

Index



16
KUNAL AIR 6
KUNAL AIR 6 XUP!
KUNAL AIR 8
KUNAL AIR 8 XUP!

22

REN AIR 6
REN AIR 6 XUP!
REN AIR 8 XUP!



28

DALIA AIR 6



30

MELISSA AIR 7 XUP!



34

CAMELIA AIR 8



38

MINTA AIR 8



42

HOYA MULTIAIR 8 XUP!



50

ASTER MULTIAIR 10 XUP!



58

LOTO MULTIAIR 14
LOTO HYDRO 16
LOTO HYDRO 23



NEW



46

ALTHEA MULTIAIR 9 (REAR/UP!)

NEW



54

MALVA MULTIAIR 10



64

FRESIA AIR 9

KUNAL



KUNAL

Air 6

Poêle à pellets rond étanche au design essentiel réalisé avec un top en fonte fuselé sur les côtés et un revêtement en acier couleurs White, Silver et Black. Brasier en fonte. Allumage rapide. Évacuation supérieure coaxiale (8/13 cm) ou arrière. Il est possible de gérer le poêle via le panneau de commande intégré ou un smartphone, grâce au kit Wi-Fi Easy Connect inclus.

Round sealed pellet stove of an essential design made with cast-iron top tapered on the sides and White, Silver and Black steel cladding. Cast iron brazier. Quick ignition. Top coaxial (8/13 cm) or rear outlet. You can choose to manage the stove via the built-in control panel or smartphone, thanks to the included Wi-Fi Easy Connect kit.

KUNAL avec sortie des fumées supérieure raccordée avec un tuyau ø 8 cm / KUNAL with top smoke outlet connected with ø 8 cm tube



White
7121051-6921030

Silver
7121051-6921031

Black
7121051-6921032

XUP! - White
7121053-6921030

XUP! - Silver
7121053-6921031

XUP! - Black
7121053-6921032

KUNAL AIR 6 S1 KUNAL AIR 6 XUP! S1

	6,3 kW
	2,4 kW
	91 - 96,9 %
	135°
	4,6 g/s
	33 l
	Pellet 6 mm. x 3-40 mm
	Min ~ 0,5 kg/h - Max. ~ 1,4 kg/h
	~ 41 h - ~ 15 h
	Voir le dessin technique See technical drawing
	115/55 - 180/35 - 315/20 m³
	Ø 80-130 mm
	Max. 345 W - Nom. 49 W
	350 Volt / 48 Hz
	100 kg

REAR		XUP!	
105,6	23,9	105,4	23,8
Ø 8 Ø 5,7	17,5	Ø 8/13,6	26,5
53,3	26,5	60,3	Ø 53
Ø 53		Ø 53	
EN 14785	CE	OK BBC	Flamme VERTE 7★
BImSchV Stufe 2	ECO DESIGN 2022	CSTB	A+
ART. 15a B-VG 2015			
REGENSBURGER/ AACHENER/ MÜNCHENER BStV			
LRV			

KUNAL

Air 8

KUNAL avec sortie des fumées supérieure coaxiale raccordée avec un tuyau ø 13 cm / KUNAL with top coaxial smoke outlet connected with ø 13 cm tube

Poêle à pellets rond étanche au design essentiel réalisé avec un top en fonte fuselé sur les côtés et un revêtement en acier couleurs White, Silver et Black. Brasier en fonte. Allumage rapide. Évacuation supérieure coaxiale (8/13 cm) ou arrière. Il est possible de gérer le poêle via le panneau de commande intégré ou un smartphone, grâce au kit Wi-Fi Easy Connect inclus.

Round sealed pellet stove of an essential design made with cast-iron top tapered on the sides and White, Silver and Black steel cladding. Cast iron brazier. Quick ignition. Top coaxial (8/13 cm) or rear outlet. You can choose to manage the stove via the built-in control panel or smartphone, thanks to the included Wi-Fi Easy Connect kit.



White
7121052-6921030



Silver
7121052-6921031



Black
7121052-6921032



XUP! - White
7121054-6921030



XUP! - Silver
7121054-6921031



XUP! - Black
7121054-6921032

KUNAL AIR 8 S1 KUNAL AIR 8 XUP! S1

	8,2 kW
	2,4 kW
	91 - 96,9 %
	149°
	5,2 g/s
	27 l
	Pellet 6 mm. x 3-40 mm
	Min ~ 0,5 kg/h - Max. ~ 1,9 kg/h
	~ 35 h - ~ 10 h
	Voir le dessin technique See technical drawing
	149/55 - 234/35 - 410/20 m ³
	Ø 80-130 mm
	Max. 350 W - Nom. 52 W
	230 Volt / 50 Hz
	100 kg

REAR

XUP!

EN 14785
BlmSchV Stufe 2
ART. 15a B-VG 2015
REGENSBURGER/
AACHENER/
MÜNCHENER BStV
LRV

REN



REN

Air 6

Poêle étanche à pellets réalisé avec top et porte en fonte, revêtement en acier couleurs White, Silver ou Black. Brasier et panneau arrière du foyer en fonte. Allumage rapide. Évacuation supérieure coaxiale (8/13 cm) ou arrière. Il est possible de gérer le poêle via le panneau de commande intégré ou un smartphone, grâce au kit Wi-Fi Easy Connect inclus.

Sealed pellet stove with cast iron top and door, White, Silver or Black steel cladding. Cast iron brazier and firebox back panel. Quick ignition. Top coaxial (8/13 cm) or rear outlet. You can choose to manage the stove via the built-in control panel or smartphone, thanks to the included Wi-Fi Easy Connect kit.

REN avec sortie des fumées supérieure raccordée avec un tuyau ø 8 cm / REN with top smoke outlet connected with ø 8 cm tube



White
7121047-6921033

Silver
7121047-6921034

Black
7121047-6921035

XUP! - White
7121049-6921033

XUP! - Silver
7121049-6921034

XUP! - Black
7121049-6921035

REN AIR 6 S1
REN AIR 6 XUP! S1

	6,3 kW
	2,4 kW
	91 - 96,9 %
	135°
	4,6 g/s
	27 l
	Pellet 6 mm. x 3-40 mm
	Min ~ 0,5 kg/h - Max. ~ 1,4 kg/h
	~ 35 h - ~ 13 h
	Voir le dessin technique See technical drawing
	115/55 - 180/35 - 315/20 m³
	Ø 80-130 mm
	Max. 350 W - Nom. 48 W
	230 Volt / 50 Hz
	100 kg

REAR		XUP!	
102,2	37,2	102,2	23,8
ø 8 ø 5,7	14	ø 8/13,6	23
48,3	23	53	46,3
46,3		46,3	
EN 14785	CE	OK BBC	Flamme VERTE
BImSchV Stufe 2			7★
ART. 15a B-VG 2015	ECO DESIGN 2022	CSTB	A+
REGENSBURGER/ AACHENER/ MÜNCHENER BStV			
LRV			

REN

Air 8

Poêle étanche à pellets réalisé avec top et porte en fonte, revêtement en acier couleurs White, Silver ou Black. Brasier et panneau arrière du foyer en fonte. Allumage rapide. Évacuation supérieure coaxiale (8/13 cm).

Il est possible de gérer le poêle via le panneau de commande intégré ou un smartphone, grâce au kit Wi-Fi Easy Connect inclus.

Sealed pellet stove with cast iron top and door, White, Silver or Black steel cladding. Cast iron brazier and firebox back panel. Quick ignition. Top coaxial (8/13 cm) outlet. You can choose to manage the stove via the built-in control panel or smartphone, thanks to the included Wi-Fi Easy Connect kit.

REN avec sortie des fumées supérieure coaxiale raccordée avec un tuyau ø 13 cm / REN with top coaxial smoke outlet connected with ø 13 cm tube



XUP! - White
7121050-6921033



XUP! - Silver
7121050-6921034



XUP! - Black
7121050-6921035

REN AIR 8 XUP! S1

	8,2 kW
	2,4 kW
	91 - 96,9 %
	149°
	5,2 g/s
	27 l
	Pellet 6 mm. x 3-40 mm
	Min ~ 0,5 kg/h - Max. ~ 1,9 kg/h
	~ 35 h - ~ 10 h
	Voir le dessin technique See technical drawing
	149/55 - 234/35 - 410/20 m ³
	Ø 80-130 mm
	Max. 350 W - Nom. 52 W
	230 Volt / 50 Hz
	100 kg

EN 14785
BlmSchV Stufe 2
ART. 15a B-VG 2015
REGENSBURGER/
AACHENER/
MÜNCHENER BStV
LRV

DALIA

 Air 6

Poêle étanche à pellets réalisé avec porte en fonte, top et revêtement en acier couleurs White, Silver, Black et Bordeaux. Foyer en fonte large et profond pour une meilleure vue du feu. Brasier en fonte. Allumage rapide. Il est possible de gérer le poêle via le panneau de commande intégré ou un smartphone, grâce au kit Wi-Fi Easy Connect inclus.

Sealed pellet stove made with cast-iron door, top and cladding in White, Silver, Black and Burgundy steel. Large and deep cast-iron firebox for a better view of the flame. Cast iron brazier. Quick ignition. You can choose to manage the stove via the built-in control panel or smartphone, thanks to the included Wi-Fi Easy Connect kit.



White
7118001S-6918004



Silver
7118001S-6918001

















Black
7118001S-6918003



Bordeaux
7118001S-6918002



DALIA AIR 6 S1

-  6,3 kW
-  2,5 kW
-  91,5 - 92 %
-  165°
-  3,7 g/s
-  24 l
-  Pellet 6 mm. x 3-40 mm
-  Min ~ 0,6 kg/h - Max. ~ 1,45 kg/h
-  ~ 26 h - ~ 11 h
-  Voir le dessin technique
See technical drawing
-  115/55 - 180/35 - 315/20 m³
-  extérieur/esterno Ø 80 mm
-  Max. 350 W - Nom. 76 W
-  230 Volt / 50 Hz
-  90 kg

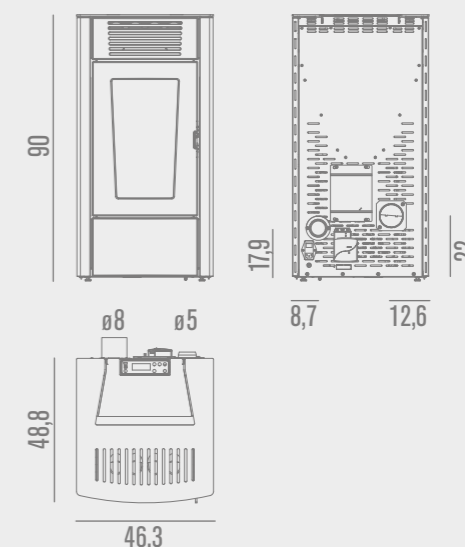

easy connect



EN 14785
BlmSchV Stufe 2
ART. 15a B-VG 2015
REGENSBURGER/
AACHENER/
MÜNCHENER BStV
LRV

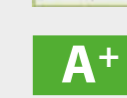



MELISSA

Poêle étanche à pellets particulièrement adapté pour de petits espaces, grâce à sa profondeur très réduite (27 cm). Porte en fonte, revêtement en acier couleurs White, Silver, Black et Bordeaux. Brasier et panneau arrière du foyer en fonte. Allumage rapide. Melissa est doté de sortie des fumées supérieure coaxiale (8/13 cm). Il est possible de gérer le poêle via le panneau de commande intégré ou un smartphone, grâce au kit Wi-Fi Easy Connect inclus.

Highly compact sealed pellet stove (27cm deep) ideal for confined spaces. Cast iron door and White, Silver, Black and Burgundy steel cladding. Cast iron brazier and firebox back panel. Quick ignition. Melissa is fitted with top coaxial (8/13 cm). You can choose to manage the stove via the built-in control panel or smartphone, thanks to the included Wi-Fi Easy Connect kit.

Sortie des fumées supérieure raccordée avec un tuyau ø 8 cm / Top smoke outlet connected with ø 8 cm tube



White
7121055-6921036



Silver
7121055-6921037



Dark
7121055-6921038



Bordeaux
7121055-6921039

MELISSA AIR 7 XUP! S1

	7 kW
	2,7 kW
	89,6 - 93,1 %
	184°
	3/4,9 g/s
	19 l
	Pellet 6 mm. x 3-40 mm
	Min ~0,61 kg/h - Max. ~1,7 kg/h
	~ 20 h - ~ 7 h
	Voir le dessin technique See technical drawing
	127/55 - 200/35 - 350/20 m³
	Ø 80-130 mm
	Max. 345 W - Nom. 72 W
	230 Volt / 50 Hz
	75 kg

EN 14785
BlmSchV Stufe 2
ART. 15a B-VG 2015
REGENSBURGER/
AACHENER/
MÜNCHENER BStV
LRV



CAMELIA

Poêle étanche à pellets réalisé avec une structure en acier, un top en fonte et des côtés en acier couleurs White, Silver, Black et Bordeaux. Foyer large et profond pour une meilleure vue du feu. Brasier en fonte. Allumage rapide. Il est possible de gérer le poêle via le panneau de commande intégré ou un smartphone, grâce au kit Wi-Fi Easy Connect inclus.

Sealed pellet stove made with a steel structure, cast iron top and White, Silver, Black and Burgundy steel sides. Large and deep firebox for a better view of the flame. Cast iron brazier. Quick ignition. You can choose to manage the stove via the built-in control panel or smartphone, thanks to the included Wi-Fi Easy Connect kit.



White
7122074-6916037



Silver
7122074-6916038



Black
7122074-6916036



Bordeaux
7122074-6916035



CAMELIA AIR 8 S2

-  8 kW
-  2,5 kW
-  90,4 - 92 %
-  196°
-  4,3 g/s
-  26 l
-  Pellet 6 mm. x 3-40 mm
-  Min ~ 0,6 kg/h - Max. ~ 1,8 kg/h
-  ~ 28 h - ~ 9 h
-  Voir le dessin technique
See technical drawing
-  145/55 - 229/35 - 400/20 m³
-  Ø 80 mm
-  Max. 350 W - Nom. 70 W
-  230 Volt / 50 Hz
-  130 kg

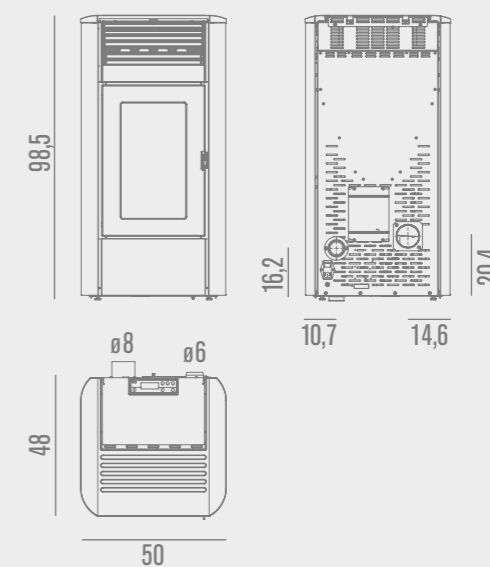

easy connect



EN 14785
BlmSchV Stufe 2
ART. 15a B-VG 2015
REGENSBURGER/
AACHENER/
MÜNCHENER BStV
LRV







Poêle étanche rond à pellets réalisé avec une structure en acier, un top et des côtés en acier couleurs White, Silver, Black et Bordeaux. Foyer large et profond pour une meilleure vue du feu. Brasier en fonte. Allumage rapide. Il est possible de gérer le poêle via le panneau de commande intégré ou un smartphone, grâce au kit Wi-Fi Easy Connect inclus.

Round sealed pellet stove made with a steel structure; White, Silver, Black and Burgundy steel top and sides. Large and deep firebox for a better view of the flame. Cast iron brazier. Quick ignition. You can choose to manage the stove via the built-in control panel or smartphone, thanks to the included Wi-Fi Easy Connect kit.



White
7122071-6918021



Silver
7122071-6918023



Black
7122071-6918022



Bordeaux
7122071-6918024

MINTA AIR 8 S2

	8,1 kW
	3,5 kW
	90,9 - 91,5 %
	188°
	4,3 g/s
	32 l
	Pellet 6 mm. x 3-40 mm
	Min ~ 0,8 kg/h - Max. ~ 1,8 kg/h
	~ 26 h - ~ 12 h
	Voir le dessin technique See technical drawing
	147/55 - 231/35 - 405/20 m ³
	Ø 80 mm
	Max. 380 W - Nom. 56 W
	230 Volt / 50 Hz
	115 kg

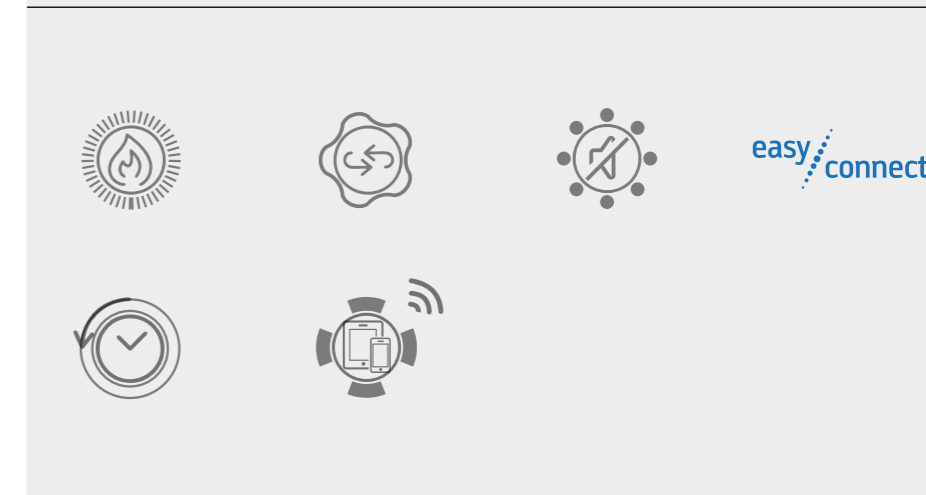
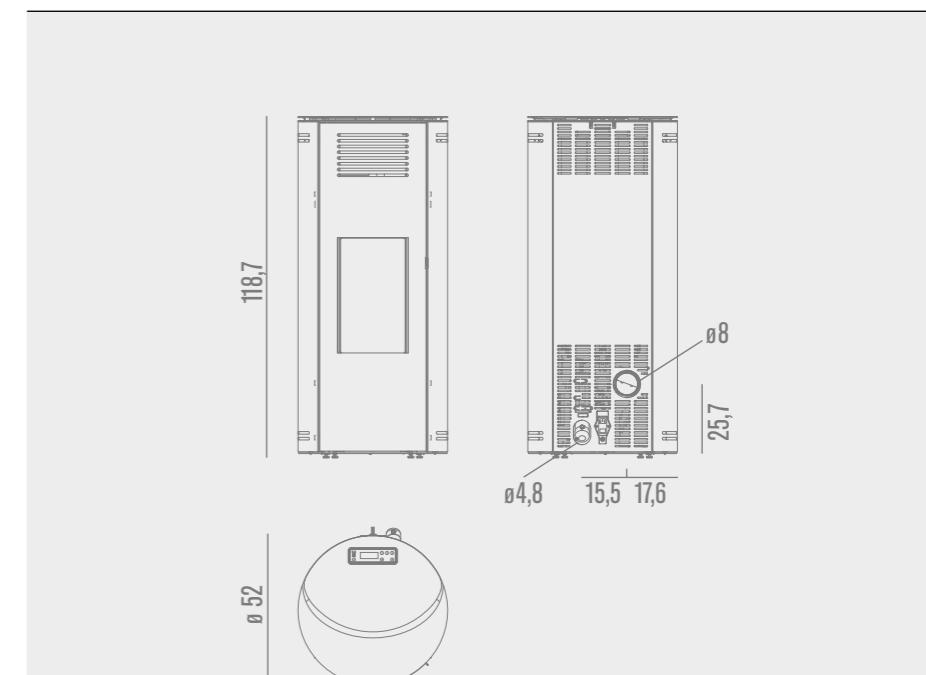

EN 14785
BlmSchV Stufe 2
ART. 15a B-VG 2015
REGENSBURGER/
AACHENER/
MÜNCHENER BStV
LRV

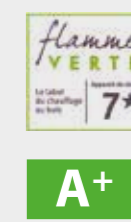



HOYA

Poêle étanche à pellets à profondeur réduite (28 cm) réalisé avec revêtement en acier couleurs Silver ou Black. Brasier, top et porte en fonte. Allumage rapide. Hoya est doté de sortie des fumées supérieure coaxiale (8/13 cm). Il est possible de gérer le poêle via le panneau de commande intégré ou un smartphone, grâce au kit Wi-Fi Easy Connect inclus.

Sealed pellet stove of reduced depth (28 cm) with Silver or Black steel cladding. Cast iron brazier, door and top. Quick ignition. Hoya is fitted with top coaxial (8/13 cm). You can choose to manage the stove via the built-in control panel or smartphone, thanks to the included Wi-Fi Easy Connect kit.

Sortie des fumées supérieure raccordée avec un tuyau ø 8 cm / Top smoke outlet connected with ø 8 cm tube



Silver
7122090-6922025



Black
7122090-6922024

HOYA MULTIAIR 8 XUP! S1

	7,8 kW
	3,6 kW
	90,2 - 90,1 %
	179°
	4,7 g/s
	28 l
	Pellet 6 mm. x 3-40 mm
	Min ~ 0,8 kg/h - Max. ~ 1,15 kg/h
	~ 23 h - ~ 10 h
	Voir le dessin technique See technical drawing
	142/55 - 223/35 - 390/20 m ³
	Ø 80-130 mm
	Max. 340 W - Nom. 90 W
	230 Volt / 50 Hz
	155 kg



ALTHEA

Poêle étanche à pellets à profondeur réduite (28 cm) réalisé avec revêtement en acier couleurs Silver ou Black. Brasier en fonte. Allumage rapide. Le modèle dispose d'évacuation supérieure et arrière ø 8 cm. Il est possible de gérer le poêle via le panneau de commande intégré ou un smartphone, grâce au kit Wi-Fi Easy Connect inclus.

Sealed pellet stove of reduced depth (28 cm) with Silver or Black steel cladding. Cast iron brazier. Quick ignition. The model has a top and rear ø 8 cm outlet. You can choose to manage the stove via the built-in control panel or smartphone, thanks to the included Wi-Fi Easy Connect kit.



Silver
7122073



À gauche : ALTHEA raccordé à la sortie des fumées arrière / On left: ALTHEA connected to rear smoke outlet



À droite : ALTHEA raccordé à la sortie des fumées supérieure / On right: ALTHEA connected to top smoke outlet

ALTHEA MULTIAIR 9 UP! S2

	8,8 kW
	3,6 kW
	90,9 - 90,5 %
	186°
	4,7 g/s
	28 l
	Pellet 6 mm. x 3-40 mm
	Min ~ 0,8 kg/h - Max. ~ 1,9 kg/h
	~ 23 h - ~ 9 h
	Voir le dessin technique See technical drawing
	160/55 - 251/35 - 440/20 m ³
	ø 80 mm
	Max. 380 W - Nom. 160 W
	230 Volt / 50 Hz
	139 kg

easy connect

EN 14785
BlmSchV Stufe 2
ART. 15a B-VG 2015
REGENSBURGER/
AACHENER/
MÜNCHENER BStV
LRV

CE

OK BBC

Flamme VERTE
7★

ECO DESIGN 2022

CSTB

A+



ASTER

Poêle étanche à pellets canalisable réalisé en acier couleurs White, Silver et Black. Porte et grille supérieure en fonte. Foyer large et profond pour une meilleure vue du feu avec brasier en fonte. Allumage rapide. Aster est doté de sortie des fumées supérieure coaxiale (8/13 cm). Il est possible de gérer le poêle via le panneau de commande intégré ou un smartphone, grâce au kit Wi-Fi Easy Connect inclus.

Ductable sealed pellet stove in White, Silver and Black steel. Cast iron door and upper grille. Large and deep firebox for a better view of the flame with cast-iron brazier. Quick ignition. Aster is fitted with top coaxial (8/13 cm). You can choose to manage the stove via the built-in control panel or smartphone, thanks to the included Wi-Fi Easy Connect kit.



White
7122089-6922027



Silver
7122089-6922028



Black
7122089-6922026



ASTER MULTIAIR 10 XUP! S1

	10 kW
	3,5 kW
	90,4 - 91,5 %
	212°
	5 g/s
	33 l
	Pellet 6 mm. x 3-40 mm
	Min ~ 0,8 kg/h - Max. ~ 2,3 kg/h
	~ 26 h - ~ 9 h
	Voir le dessin technique See technical drawing
	182/55 - 286/35 - 500/20 m ³
	Ø 80-130 mm
	Max. 340 W - Nom. 108 W
	230 Volt / 50 Hz
	130 kg

EN 14785
BlmSchV Stufe 2
ART. 15a B-VG 2015
REGENSBURGER/
AACHENER/
MÜNCHENER BStV
LRV



MALVA

Poêle étanche à pellets canalisable réalisé en acier couleurs White, Silver, Black et Bordeaux. Foyer large et profond pour une meilleure vue du feu avec brasier en fonte. Allu-mage rapide. Il est possible de gérer le poêle via le panneau de commande intégré ou un smartphone, grâce au kit Wi-Fi Easy Connect inclus.

Ductable sealed pellet stove in White, Silver, Black and Burgundy steel. Large and deep firebox for a better view of the flame with cast-iron brazier. Quick ignition. You can choose to manage the stove via the built-in control panel or smartphone, thanks to the included Wi-Fi Easy Connect kit.



White
7122072-6917003



Silver
7122072-6917004

















Black
7122072-6917001







Bordeaux
7122072-6917002



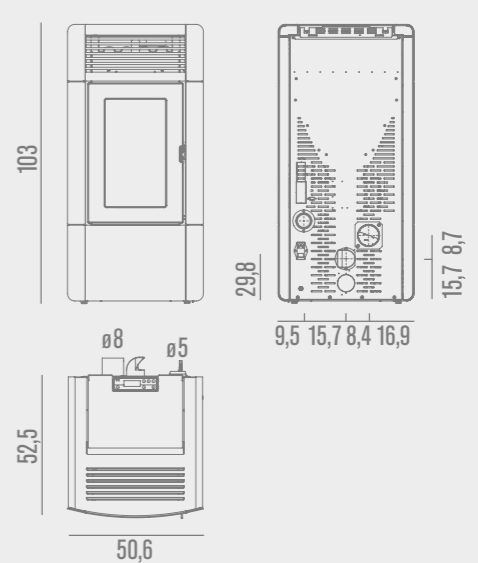

MALVA MULTIAIR 10 S2

-  10 kW
-  3,5 kW
-  90,4 - 91,5 %
-  212°
-  5 g/s
-  39 l
-  Pellet 6 mm. x 3-40 mm
-  Min ~ 0,8 kg/h - Max. ~ 2,3 kg/h
-  ~ 51 h - ~ 11 h
-  Voir le dessin technique
See technical drawing
-  182/55 - 286/35 - 500/20 m³
-  Ø 80 mm
-  Max. 340 W - Nom. 108 W
-  230 Volt / 50 Hz
-  130 kg















KIT XUP!

EN 14785
BlmSchV Stufe 2
ART. 15a B-VG 2015
REGENSBURGER/
AACHENER/
MÜNCHENER BStV
LRV















Poêle étanche à pellets réalisé avec un top en fonte et des côtés en acier couleurs White, Silver, Black et Bordeaux. Foyer large et profond avec brasier en fonte. Allumage ra-pide. Disponible en version air canalisable et hydro (16 ou 23 kW). Il est possible de gérer le poêle via le panneau de commande intégré ou un smartphone, grâce au kit Wi-Fi Easy Connect inclus.

Sealed pellet stove with cast iron top and White, Silver, Black and Burgundy steel sides. Large and deep firebox with cast-iron brazier. Quick ignition. Available in ductable air and hydro version (16 or 23 kW). You can choose to manage the stove via the built-in control panel or smartphone, thanks to the included Wi-Fi Easy Connect kit.



White
7122075-6916026



Silver
7122075-6916025



Black
7122075-6916027



Bordeaux
7122075-6916028



LOTO MULTIAIR 14 S2

	13,8 kW
	3,9 kW
	90,5 - 93,5 %
	205°
	7,1 g/s
	46 l
	Pellet 6 mm. x 3-40 mm
	Min ~0,9 kg/h - Max. ~3,1 kg/h
	~ 33 h - ~ 10 h
	Voir le dessin technique See technical drawing
	251/55 - 394/35 - 690/20 m ³
	Ø 80 mm
	Max. 380 W - Nom. 129 W
	230 Volt / 50 Hz
	165 kg

EN 14785
BlmSchV Stufe 2
ART. 15a B-VG 2015
REGENSBURGER/
AACHENER/
MÜNCHENER BStV
LRV



White
7122034-6916026



Silver
7122034-6916025



Black
7122034-6916027



Bordeaux
7122034-6916028



White
7122035-6916026



Silver
7122035-6916025



Black
7122035-6916027



Bordeaux
7122035-6916028

LOTO HYDRO 16 S2

⚡ 16,1 (12,9 H₂O) kW

⚡ 4,9 (3,4 H₂O) kW

🔥 93,7 - 96,7 %

🌡️ 116°

📈 9,8 g/s

🗑️ 40 l

🔪 Pellet 6 mm. x 3-40 mm

🕒 Min ~ 1,1 kg/h - Max. ~ 3,6 kg/h

🕒 ~ 24 h - ~ 7 h

📄 Voir le dessin technique
See technical drawing

📦 293/55 - 460/35 - 805/20 m³

📏 Ø 80 mm

⚡ Max. 343 W - Nom. 117 W

⚡ 230 Volt / 50 Hz

📖 185 kg

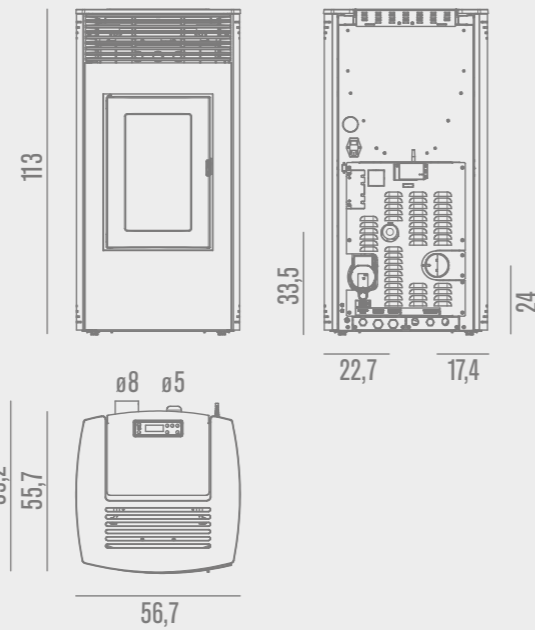

EN 14785
BlmSchV Stufe 2
ART. 15a B-VG 2015
REGENSBURGER/
AACHENER/
MÜNCHENER BstV
LRV



LOTO HYDRO 23 S2

⚡ 22,4 (18 H₂O) kW

⚡ 4,9 (3,4 H₂O) kW

🔥 92 - 96,7 %

🌡️ 153°

📈 12,1 g/s

🗑️ 40 l

🔪 Pellet 6 mm. x 3-40 mm

🕒 Min ~ 1,1 kg/h - Max. ~ 5,1 kg/h

🕒 ~ 24 h - ~ 5 h

📄 Voir le dessin technique
See technical drawing

📦 407/55 - 640/35 - 1.120/20 m³

📏 Ø 80 mm

⚡ Max. 343 W - Nom. 117 W

⚡ 230 Volt / 50 Hz

📖 185 kg

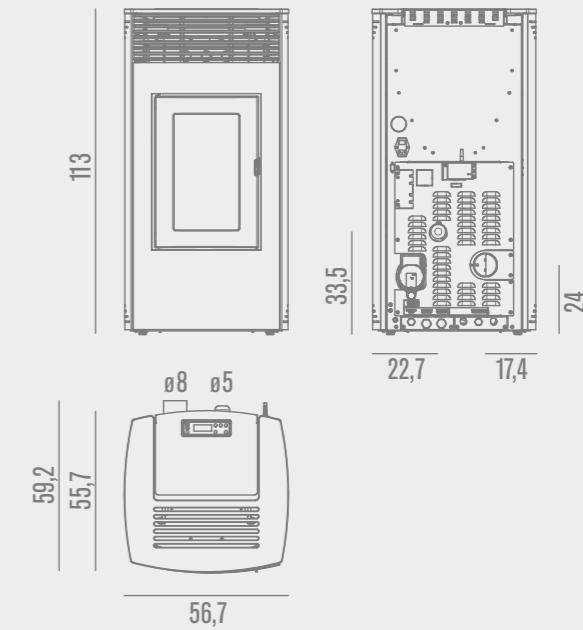

EN 14785
BlmSchV Stufe 2
ART. 15a B-VG 2015
REGENSBURGER/
AACHENER/
MÜNCHENER BstV
LRV



FRESIA

☞ Air 9

Insert à pellets avec chargement frontal du combustible par tiroir intégré. Convenant pour l'insertion dans des foyers existants ou pour de nouvelles installations. Il est possible de gérer l'insert via le panneau de commande intégré ou un smartphone, grâce au kit Wi-Fi.















Pellet insert with front fuel loading through a built-in drawer. Suitable for insertion in existing fireboxes or for new installations. You can choose to manage the insert via the built-in control panel or smartphone, thanks to the Wi-Fi kit.



Black
5019005S



FRESIA 70 AIR 9 S1

-  8,8 kW
-  2,5 kW
-  90,6 - 94,1 %
-  188°
-  5 g/s
-  20 l
-  Pellet 6 mm. x 3-40 mm
-  Min ~ 0,6 kg/h - Max. ~ 2 kg/h
-  ~ 21 h - ~ 6 h
-  Voir le dessin technique
See technical drawing
-  160/55 - 251/35 - 440/20 m³
-  Ø 80 mm
-  Max. 306 W - Nom. 75 W
-  230 Volt / 50 Hz
-  135 kg

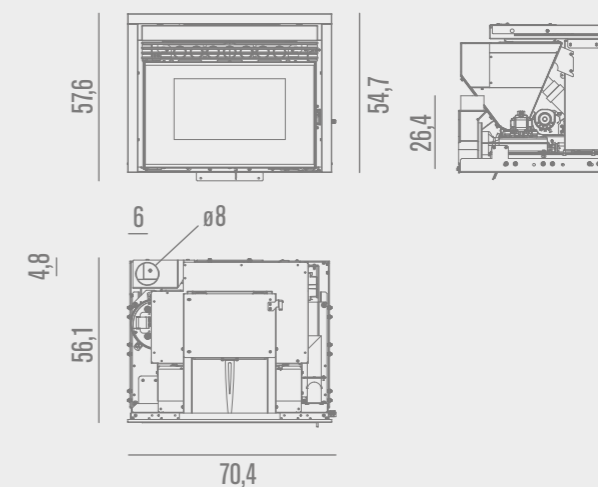

easy connect

EN 14785

BImSchV Stufe 2





ART. 15a B-VG 2015

REGENSBURGER/
AACHENER/
MÜNCHENER BStV

LRV



LÉGENDE / KEY

	Puissance utile nominale	Nominal heat output
	Puissance utile minimale	Minimum heat output
	Rendement utile nominal	Nominal efficiency
	Température des fumées	Smoke temperature
	Débit massique des fumées	Fluegas mass flow
	Capacité du réservoir	Hopper capacit
	Type de combustible	Fuel type
	Autonomie avec une charge	Running time with one load
	Autonomie	Running time
	Dimensions	Dimensions
	Volume de chauffe (55-35-20 Kcal/m ³ h)	Heatable volume (55-35-20 Kcal/m ³ h)
	Diamètre du conduit de sortie des fumées	Diameter of flue pipe
	Puissance électrique maximale absorbée	Maximum electricity consumption
	Tension d'alimentation	Power voltage
	Poids	Weight



redheating.it
info@redheating.it